

STRIPE COLLECTION by Lagranja Design

The defining feature of the Stripe Collection lies in its distinctive lines, creating a dynamic and refined aesthetic. Its signature weaving is not just a decorative element but an integral part of the structure, providing both strength and flexibility. A modern touch that remains true to its natural and organic essence. Beyond its striking appearance, Stripe is designed for durability and functionality. Crafted from weather-resistant teak, it withstands various outdoor conditions without compromising comfort.



Remarks

- Table top Solid teak wood FSC 100% and porcelanic surface
- Stretching Stainless steel powder coated
- Base Solid teak wood FSC 100%
- Fittings Stainless steel 304
- Glides PA rubber
- Dining tables Include adjusters
- Packaging Carton box double wall K275, plastic free

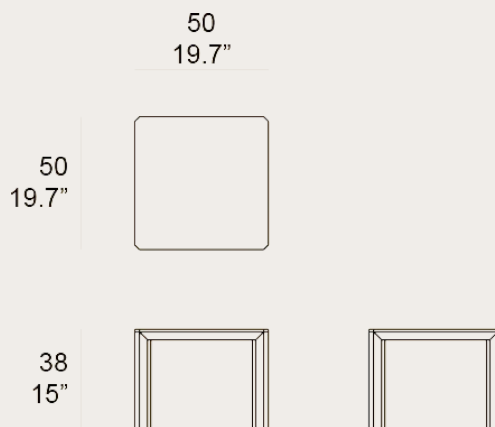

Square Side Table 50

OTAZEN

OTASTR08B

Finishing



Finishing

Natural Teak

Teak Wood



Natural Teak

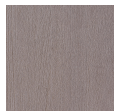

Weathered Teak

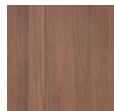

Protected Teak



Black Teak

Top Surface



Top Surface

Bronzo Bruno Matte

Teak Wood



Natural Teak



Weathered Teak



Protected Teak

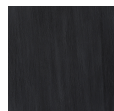

Black Teak

Porcelanic Surface



Bronzo Bruno Matte



Marquina Nero Matte

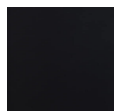

Nebula Nero Matte

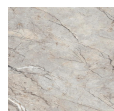

Salika Grigio Matte



Hutan Ubud Matte

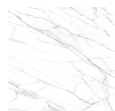

Statuario Altissimo



Daino Royale Matte

Raincover



Square Side Table 50

OTAZEN

OTASTR08B

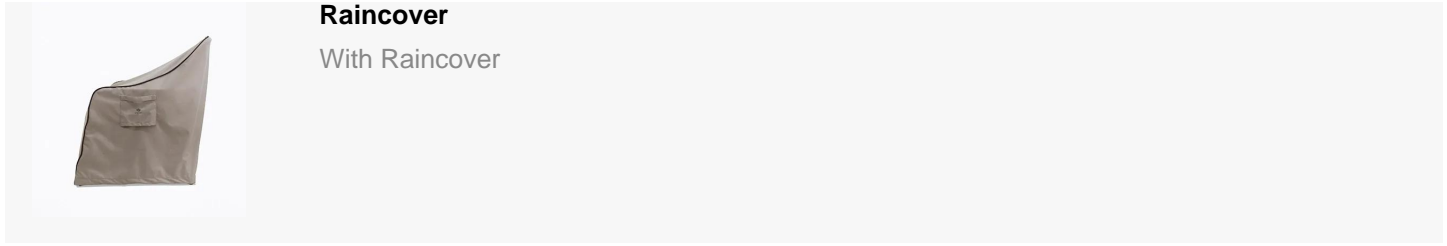

With
Raincover



Without
Raincover

